

# Active Ventilation Products

Newburgh, NY • roofvents.com

845-565-7770 • sales@roofvents.com



## Manufactured Roof Curbs 07 72 13

### Roof Curb 3-Part Spec – Model: *RC-36-H18*



**Definition / Purpose** – A roof curb is a metal or wood box that is installed onto the roof deck. This extension provides a platform to mount a roof vent, roof exhaust fan, skylight or provide an airway for a HVAC unit. Roof Curbs can also be used as a hatch or an access panel when there is no access or very difficult access from the interior (ceiling). The attic cavities provide passage ways for electrical wiring, sprinkler pipes, plumbing and HVAC duct work. Access from the roof (top side) may be the only and easiest option.

**Material** – Traditionally, roofers build wooden boxes on the roof at the time of the installation. Using prefabricated aluminum curbs eliminates the time to build the wooden boxes while on the roof. This will lower the risk of injury to the roofing crew by lowering the time spent on the roof and using power tools to build the wood boxes while on the roof. In addition, any chances of damage to the roof in the roof curb building process are also eliminated. Another safety feature is that aluminum curbs are not flammable. The majority of curbs vent out heat from range hoods or HVAC units. Wooden curbs are combustible material. Aluminum is not combustible and will not burn, rust, corrode or provide an environment for mold growth. Aluminum curbs are safer and easy to clean.

**Height Options** – Heights of 6", 8", 12" and 18" are available. The height options are engineered for different climate zones. For warm tropical climates that don't experience any snow fall, a 6" tall roof curb would be sufficient. For mild climates that experience little snow, an 8" tall roof curb is recommended. The 8" tall curbs are the most popular height for roofing manufacture warranties. For climates that experience significant amounts of snow, 12" high curbs are ideal. Lastly, the cold or high alpine areas that commonly experience heavy snowfall during winters should use the 18" high curbs. See <https://roofvents.com/climate-zones-for-roof-curbs/> for more details.

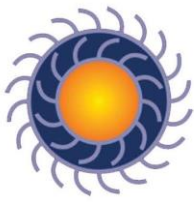

# Active Ventilation Products

Newburgh, NY • [roofvents.com](http://roofvents.com)

845-565-7770 • [sales@roofvents.com](mailto:sales@roofvents.com)



**Warranty** – An essential reason for using a roof curb is for a roofing manufacturer's warranty. Many EPDM, PVC & TPO roofing manufacturers require roofing penetrations to be secured by a curb and a boot. Check with your roofing materials supplier to purchase a boot that slides over the aluminum curb.

AVP's Roof Curbs are proudly designed, manufactured, and assembled in the U.S.A.

This guide is written under Construction Specifications Institute (CSI) 3-Part Specification using CSI *MasterFormat 2020 Edition*. All section numbers and titles are based on *MasterFormat 2020 Edition*.

**The CSI Master number classification for this product's division, subsection number and titles are the following;**

07 00 00 Division: Thermal and Moisture Protection:

07 72 00 Section: Roof Accessories

07 72 13 Title: Manufactured Curbs

**Company Bio:** Active Ventilation Products, Inc. (AVP) was founded in 1997 and is an innovative sheet metal fabrication facility located in Newburgh, NY. AVP produces high-quality spun aluminum roof vents, commercial roof exhaust fans, residential attic fans, solar attic fans, roof curbs, pitch pockets and other roof accessories. Roof Vents range in size from 3 inches up to 48 inches in diameter. Collar heights range from 1 inch up to 12 inches in height.

Headquartered in the Hudson Valley of New York, AVP is housed in a 63,000-square-foot building with over 50 sheet metal fabricators on staff.

The management of Active Ventilation Products is committed to providing high-quality products and services that meet or exceed the customers' expectations. It is believed that quality is a result of the process involving continuous improvement, innovation, and learning.

Active Ventilation Products, Inc., is located at:

311 1<sup>st</sup> Street, Newburgh NY 12550

(845) 565-7770

[www.roofvents.com](http://www.roofvents.com)

[sales@roofvents.com](mailto:sales@roofvents.com)

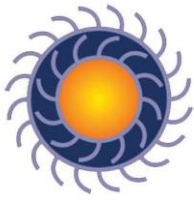

# Active Ventilation Products

Newburgh, NY • roofvents.com

845-565-7770 • sales@roofvents.com



## PART 1 General

### 1.1 Summary

#### A. Section Includes:

1. Roof Curb, RC-36-H18 acts as an extension from the roof deck, providing a platform to a roof vent, roof exhaust fan or solar attic fan.

#### B. Related Documents

1. Section 07 50 00 – Membrane Roofing
2. Section 07 60 00 – Flashing and Sheet Metal
3. Section 07 70 00 – Roof and Wall Specialties and Accessories
4. Section 07 72 00 – Roof Accessories
  - a. Section 07 72 13 – Manufactured Curbs
5. Section 07 92 00 – Joint Sealants

### 1.2 Reference Standards

#### A. Material Testing Standards:

1. Aluminum Standards:
  - a. ASTM B 209/B 209M – Specification for Aluminum and Aluminum-Alloy Sheet and Plate
2. Fastener Standards:
  - a. ASTM F593 – (National) Standard Specification for Stainless Steel Bolts, Hex Cap Screws, and Studs

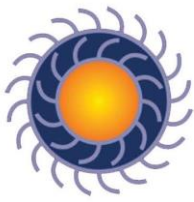

# Active Ventilation Products

Newburgh, NY • [roofvents.com](http://roofvents.com)

845-565-7770 • [sales@roofvents.com](mailto:sales@roofvents.com)



## B. Test Methods:

1. ASTM E330 – (National) Standard Test Method for Structural Performance of Exterior Windows, Doors, Skylights and Curtain Walls by Uniform Static Air Pressure Difference
  - a. ASTM E1886 – (National) Standard Test Method for Performance of Exterior Windows, Curtain Walls, Doors, and Impact Protective Systems Impacted by Missile(s) and Exposed to Cyclic Pressure Differentials
2. TAS 202 – (State of Florida) Criteria for Testing Impact & Non-impact Resistant Building Envelope Components Using Uniform Static Air Pressure
3. FBC (HVHZ) – Florida Building Code (High-Velocity Hurricane Zones), Regulated by Chapter 31 of the Florida Building Code – Residential.

## C. Certifications



1. Florida Building Code 2017 – ASTM E330 & TAS 202: In progress
2. Miami-Dade County: In progress
3. Underwriters Laboratory (UL): In progress
4. Texas Department of Insurance: In progress

## 1.3 Submittals

A. Product Data: Active Ventilation Products, Inc. standard specifications and descriptive literature including:

1. Technical Specification product sheet, in PDF located at [roofvents.com/drawings](http://roofvents.com/drawings)
2. Technical Specification product sheet, in CAD located at [roofvents.com/drawings](http://roofvents.com/drawings)
3. Technical Specification product sheet, in BIM located at [roofvents.com/drawings](http://roofvents.com/drawings)

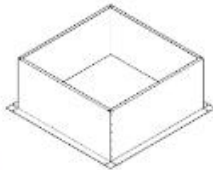
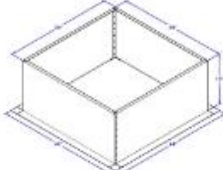
## Roof Curbs - 18 inch Tall

Product Link	Drawing - Unmarked	Drawing - Dimensioned	Revit Model
<a href="#">RC-36-H18</a>			

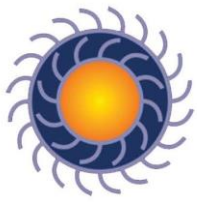

# Active Ventilation Products

Newburgh, NY • roofvents.com

845-565-7770 • sales@roofvents.com



## B. Manufacturer's Written Instructions

<p><b>Screw Pattern (Symmetrical for all sides)</b></p> <p>Hypotenuse = 52"</p> <p>37"</p> <p>4.5"</p> <p>6"</p> <p>6"</p> <p>6"</p> <p>6"</p> <p>6"</p> <p>6"</p> <p>6"</p> <p>4.5"</p> <p>1.25"</p> <p>1.25"</p> <p>2.5"</p> <p>2.5"</p> <p>39"</p> <p>Screws</p>	<p><b>Roof Curb Flashing Detail</b></p> <p>Roof Vent</p> <p>Curb Mount Flange</p> <p>For Curbs without a Boot</p> <p>Roof Curb</p> <p>Screw</p> <p>Membrane</p> <p>Insulation</p> <p>Wood nailer</p> <p>Roof deck</p> <p>Fastener Detail from Side View</p> <p>For Curbs with a Boot (EPDM, PVC, TPO)</p> <p>Exhaust</p> <p>Intake</p> <p>Duct from Below or Attic Space</p>
<ul style="list-style-type: none"> <li>- Aluminum Alloy 3003-H14</li> <li>- Thickness = 0.040" ± 0.005</li> <li>- Tolerance = ± .25 (1/4")</li> </ul> <p><b>Angled View</b></p>	<p><b>Roof Curb Installation Instructions</b></p> <ol style="list-style-type: none"> <li>1. Cut a square or round hole 37" in diameter in the roof deck.</li> <li>2. Total number of screws needed for flange = 24</li> <li>3. <i>Recommended installation screw: Flat, Bugle or Wafer Head #10 x 1 1/2" Sheet Metal Screw, Type A Point</i></li> <li>4. Flash roof curb onto deck according to specifications of the membrane manufacturer.</li> <li>5. Screws not included.</li> </ol> <p><b>Roof Curb Model: RC-36-H18</b>          Inside Opening: 37", Outside Length &amp; Width: 39", Height: 18"</p> <p> <b>Active Ventilation Products, Inc.</b>          Website: roofvents.com Email: sales@roofvents.com</p> <p>11/17/2023</p>

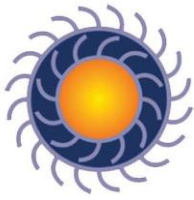

# Active Ventilation Products

Newburgh, NY • [roofvents.com](http://roofvents.com)

845-565-7770 • [sales@roofvents.com](mailto:sales@roofvents.com)



## 1.1 Quality Assurance

### A. Active Ventilation Products' Qualifications:

1. Active Ventilation Products has documented experience specializing in manufacturing roof vents since 1997. We have in place quality standards and quality control procedures followed in each phase of the manufacturing process, in accordance with the requirements of ISO 9001:2015.

### B. Installer's Qualifications:

1. Installer has specialized experience of work similar to that specified for this project, following manufacturer's installation instructions.

## 1.2 Information Submittals

- A. Coordination Drawings: Show the roof plan drawn to scale and indicate location of model RC-36-H18. See *Placement Instructions* on <https://roofvents.com/placement-instructions>

## 1.3 Delivery, Storage and Handling

- A. Delivery Requirements: Deliver materials to site in manufacturer's original, unopened containers and packaging.
- B. Store vents in a secure location protected from theft and damage.

## 1.4 Coordination

- A. Provide drawings that show the locations of the RC-36-H18 to the general contractor and roofer.
- B. Provide installation instructions of the RC-36-H18 to the general contractor and roofer.
- C. Provide this product specification to the general contractor and roofer.

## 1.5 Warranty

- A. Manufacturer's 5-year warranty – Written warranty provided at [roofvents.com/warranties](http://roofvents.com/warranties)

- END OF PART 1 OF 3 -



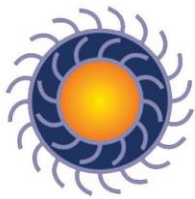

# Active Ventilation Products

Newburgh, NY • [roofvents.com](http://roofvents.com)

845-565-7770 • [sales@roofvents.com](mailto:sales@roofvents.com)



## PART 2 Products

### 2.1 Acceptable Manufacturers

A. Active Ventilation Products, Inc.,

311 1<sup>st</sup> Street, Newburgh, NY 12550

Website: <http://www.roofvents.com/>

Phone: 845-565-7770

E-mail: [sales@roofvents.com](mailto:sales@roofvents.com)

B. Substitutions: Not permitted

C. Request for substitutions will be considered in accordance with provisions of Section 01 60 00 - Product Requirements and notification to Active Ventilation Products, Inc.

### 2.2 Roof Curb

A. Roof Curb – Model RC-36-H18, H18 Series

B. Description: RC-36-H18 has 2 components; Gussets. The Gussets & Curb box are fused together using fasteners.

1. Material for Roof Curb: Aluminum

a. Box

(i) Thickness: 0.040 inch

(ii) Alloy: 3003 H14 Half Hard

b. Gussets

(i) Thickness: 0.040 inch

(ii) Alloy: 3003 H14 Half Hard

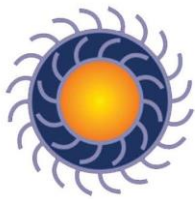

# Active Ventilation Products

Newburgh, NY • [roofvents.com](http://roofvents.com)

845-565-7770 • [sales@roofvents.com](mailto:sales@roofvents.com)



2. Material for Fasteners: Stainless Steel
  - a. Fasteners – located on 4 top corners
    - (i) Alloy: 410 Stainless Steel
    - (ii) Size: #6 x 3/8"
    - (iii) Head: Square Drive
    - (iv) Point: AB Point, Self-Tapping
3. Size:
  - a. Inside opening: 37 inches
  - b. Width of Box: 39 inches
  - c. Width of Flange: 44 inches
  - d. Height of Curb: 18 inches
  - e. Minimum Pitch Capacity: 0/12
  - f. Maximum Pitch Capacity: 12/12
  - g. Recommended use for: 0/12, 1/12 or 2/12 pitch
    - (i) If 3/12 or higher, the Roof Curb must be leveled out with a wood wedge or use a Pitched Roof Curb.
4. Standard Finish: Mill finished aluminum
5. Operation: Roof penetration used in conjunction with Curb Mounted Gravity Ventilators or Powered Fans. Vibration isolation for HVAC machinery. Increases energy efficiency, and reduces condensation of roof.



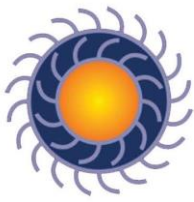

# Active Ventilation Products

Newburgh, NY • roofvents.com

845-565-7770 • sales@roofvents.com

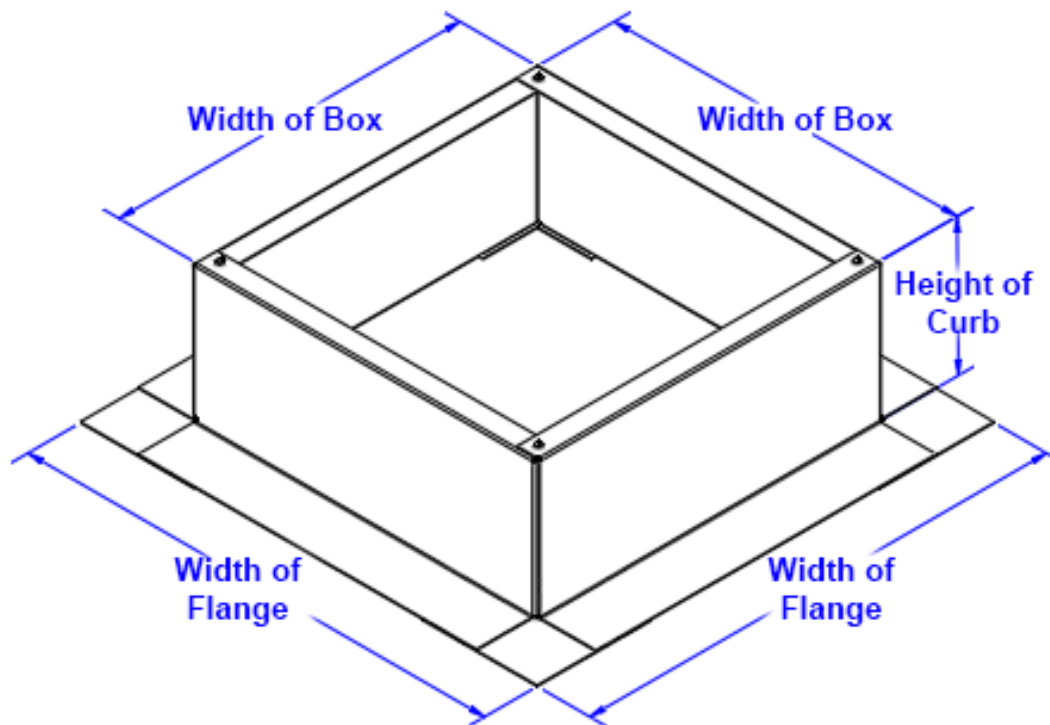

- END OF PART 2 OF 3 -

## PART 3 Execution

### 3.1 Examination

A. Examine site conditions and verify that structural supports and openings are properly sized, prepared and ready to receive the Roof Curb model RC-36-H18.

1. Proceed with installation only after unacceptable conditions have been remedied.

### 3.2 Preparation

- A. From the building plans locate the placement of Roof Curb RC-36-H18 on the roof.
- B. Prepare roof deck to receive the RC-36-H18 with the accessories in accordance with the written installation instructions.

### 3.3 Flat Roof Installation

- A. Flat Roof Detailed Installation Instructions:

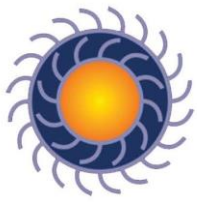

# Active Ventilation Products

Newburgh, NY • [roofvents.com](http://roofvents.com)

845-565-7770 • [sales@roofvents.com](mailto:sales@roofvents.com)



## Step 1:

From the inside of the building, plot where the roof curb will be placed. Then, drill a pilot hole through the roof deck. Insert a carpenter pencil so it is visible from the top side of the roof deck.



## Step 2:

Place the roof curb over where the pencil is sticking up from below. Then, use the roof curb flange as your pattern to outline the placement of the roof curb.

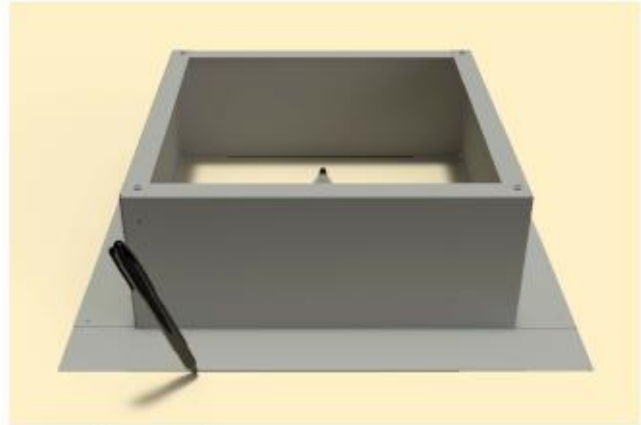

## Step 3:

With a marker, trace the inside of the box so that the section of the roof membrane is marked to cut.

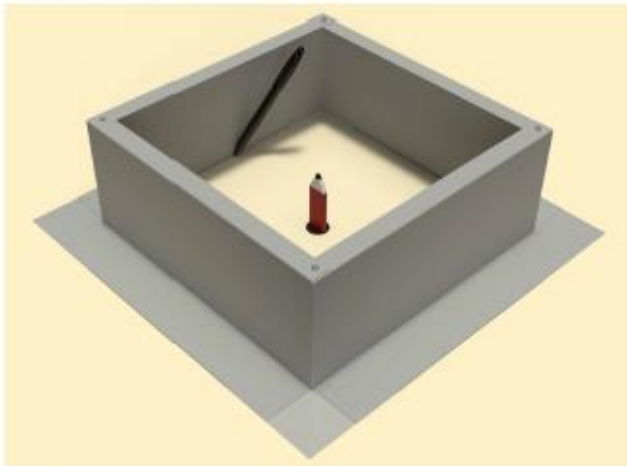

## Step 4:

Cut the membrane with a box cutter.

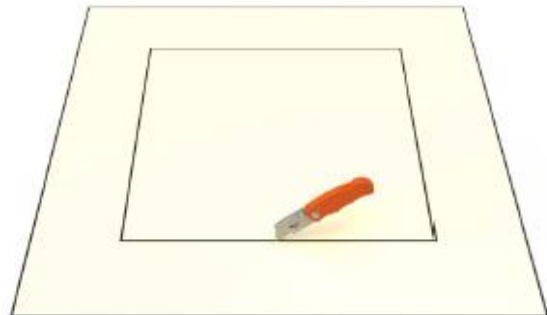



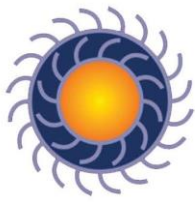

# Active Ventilation Products

Newburgh, NY • [roofvents.com](http://roofvents.com)

845-565-7770 • [sales@roofvents.com](mailto:sales@roofvents.com)



## Step 9:

Apply roofing adhesive on the flange, making sure to cover all screws and the entire roof curb, except the top lip.

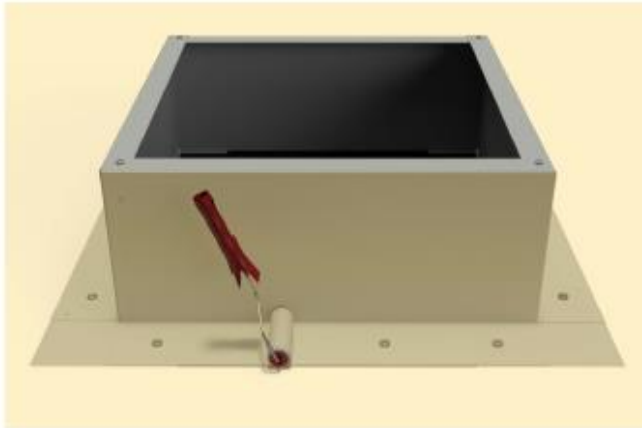

## Step 10:

Drop down the TPO boot over the roof curb.

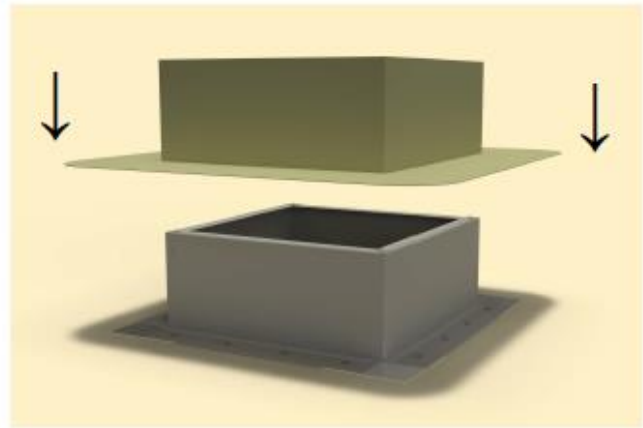

## Step 11:

Apply a generous amount of heat & pressure to TPO boot to weld it on to the curb & the deck.



## Step 12:

Install roof vent, exhaust fan or pipe cap over curb using recommended screw. See appropriate Vent with Curb Mount Flange installation instructions at [roofvents.com](http://roofvents.com) for more details.

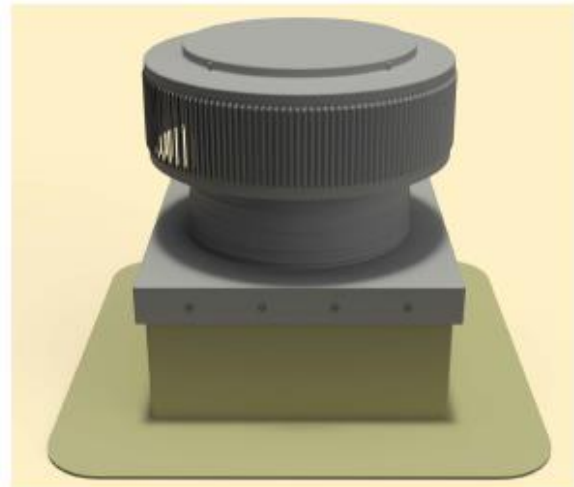

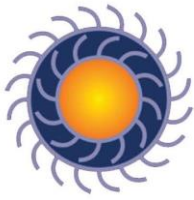

# Active Ventilation Products

Newburgh, NY • roofvents.com

845-565-7770 • sales@roofvents.com



## B. Accessories to be provided by installer:

1. Sealant: Installer provides sealant recommended for the application and type by roofing manufacturer or construction material manufacturer. Comply with requirements of Section 07 92 00 – Joint Sealants.
2. Fasteners: Installer provides corrosion resistant Flat, Bugle or Wafer Head #10 x 1 ½” Sheet Metal Screws, Type A Point.

## 3.4 Cleanup

- A. Upon completion, remove surplus materials, rubbish, tools and equipment.

- END OF PART 3 OF 3 -